

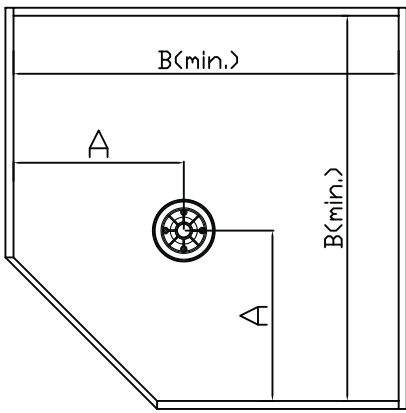

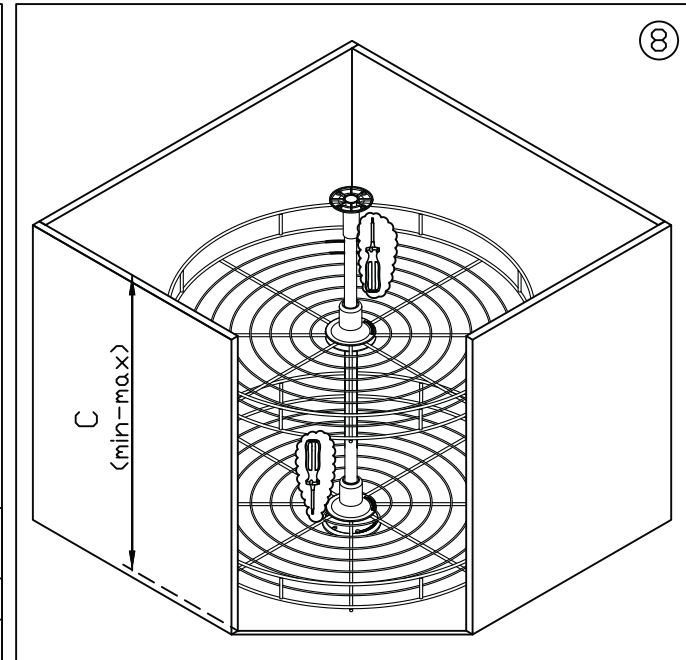

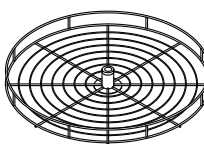

⑦



	∅	A	B (min.)	C (min.max.)
S-3033	600	390	690	670-740
S-3034	750	440	815	670-740



NO	PARÇA RESMI/ PART DRAWING	AD./PCS.
1		2
2		1
3		1
4		2
5		1
6		2
7		1