

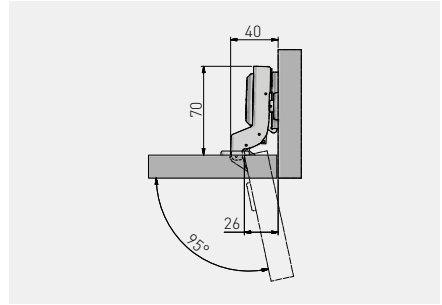





Zawias hydrauliczny CNHC z regulacją mimośrodową, wpuszczany
 Hydraulic cup hinge CNHC with eccentric adjustment, inset door
 Гидравлическая петля CNHC с эксцентриком, внутренняя



					
ZM-CNHC07BR2	H=0	x 2	x 2	nikiel nickel никель	stal steel сталь

